



TECO

Portable Air Conditioner

USER'S MANUAL

Original instructions

TP035CFWET

TP035HFWET

TECOAIR[®]



READ AND SAVE THESE INSTRUCTIONS

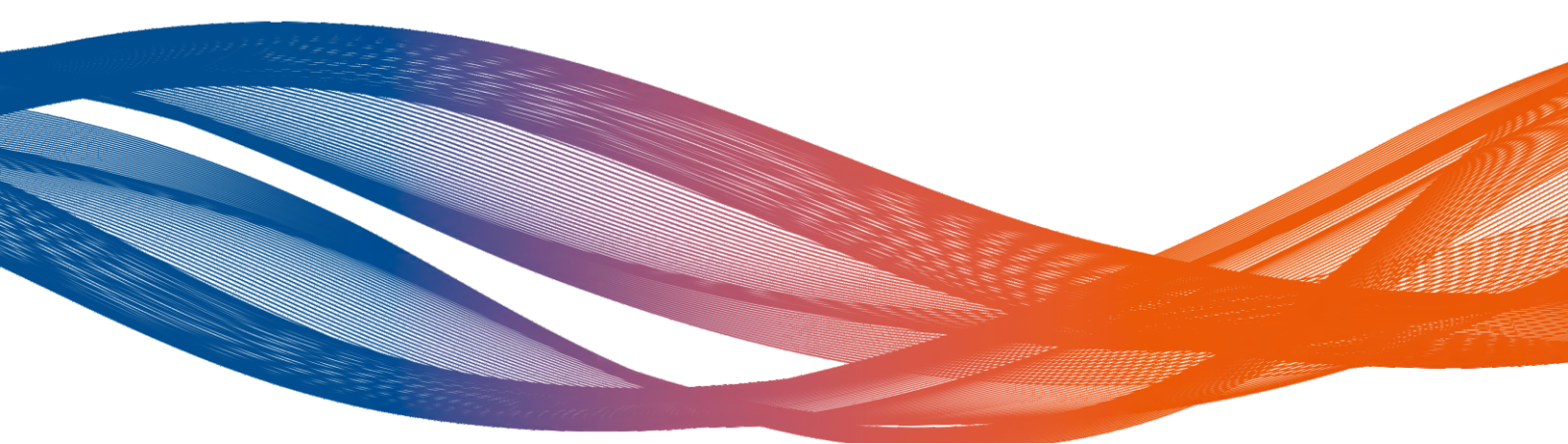

Content

SAFETY WARNING	1
DESCRIPTION.....	2
INSTALLATION INSTRUCTIONS.....	3
DECTRIPTION OF THE DISPLAY SCREEN.....	6
OPERATION INTRODUCTION FOR CONTROL PANEL.....	7
USING THE REMOTE CONTROL.....	10
REMOVING COLLECTED WATER.....	16
CLEAN AND MAINTENANCE.....	18
TROUBLESHOOTING	20
REPAIRS, SERVICE & WARRANTY	22

SAFETY WARNING

Specific information regarding appliances with R290 refrigerant gas

- Thoroughly read all of the warnings.
- When defrosting and cleaning the appliance, do not use any tools other than those recommended by the manufacturing company.
- The appliance must be placed in an area without any continuous sources of ignition (for example: open flames, gas or electrical appliances in operation).
- Do not puncture and do not burn.
- Refrigerant gases can be odourless.
- The appliance must be installed, used and stored in an area that is greater than 13 m².
- R290/R32 is a refrigerant gas that complies with the European directives on the environment. Do not puncture any part of the refrigerant circuit.
- If the appliance is installed, operated or stored in a non-ventilated area, the room must be designed to prevent the accumulation of refrigerant leaks resulting in a risk of fire or explosion due to ignition of the refrigerant caused by electric heaters, stoves, or other sources of ignition.
- The appliance must be stored in such a way as to prevent mechanical failure.
- Individuals who operate or work on the refrigerant circuit must have the appropriate certification issued by an accredited organisation that ensures competence in handling refrigerants according to a specific evaluation recognized by associations in the industry.
- Repairs must be performed based on the recommendations from the manufacturing company.
- Maintenance and repairs that require the assistance of other qualified personnel must be performed under the supervision of an individual specified in the use of flammable refrigerants.

SAFETY WARNING

- Do not use means to accelerate the defrosting process or to clean, other than those recommended by the manufacturer.
- The appliance shall be stored in a room without continuously operating ignition sources (for example: open flames, an operating gas appliance or an operating electric heater).
- Do not pierce or burn.
- Be aware that the refrigerants may not contain an odour.
- Compliance with national gas regulations shall be observed.
- Keep ventilation openings clear of obstruction.
- The appliance shall be stored so as to prevent mechanical damage from occurring.
- A warning that the appliance shall be stored in a well-ventilated area where the room size corresponds to the room area as specified for operation.
- Any person who is involved with working on or breaking into a refrigerant circuit should hold a current valid certificate from an industry-accredited assessment authority, which authorises their competence to handle refrigerants safely in accordance with an industry recognised assessment specification.
- Servicing shall only be performed as recommended by the equipment manufacturer.
- Maintenance and repair requiring the assistance of other skilled personnel shall be carried out under the supervision of the person competent in the use of flammable refrigerants.
- Appliance should be installed, operated and stored in a room with a floor area refers to the table below:

Refrigerant charged(g)	Recommended minimum area (m ²)	Recommended minimum volume (m ³)
< 152	4	60
152 - 185	9	75
186 - 225	11	90
226 - 270	13	110
271 - 290	14	120

SAFETY WARNING

WARNING: System contains refrigerant under very high pressure. The system must be serviced by qualified persons only.

1. Transport of equipment containing flammable refrigerants (Annex CC.1)

Compliance with the transport regulations

2. Marking of equipment using signs (Annex CC.2)

Compliance with local regulations

3. Disposal of equipment using flammable refrigerants (Annex CC.3)

Compliance with national regulations

4. Storage of equipment/appliances (Annex CC.4)

The storage of equipment should be in accordance with the manufacturer's instructions.

5. Storage of packed (unsold) equipment (Annex CC.5)

Storage package protection should be constructed such that mechanical damage to the equipment inside the package will not cause a leak of the refrigerant charge. The maximum number of pieces of equipment permitted to be stored together will be determined by local regulations.

6. Information on servicing (Annex DD.3)

- 1) Checks to the area

Prior to beginning work on systems containing flammable refrigerants, safety checks are necessary to ensure that the risk of ignition is minimised. For repair to the refrigerating system, the following precautions shall be complied with prior to conducting work on the system.

- 2) Work procedure

Work shall be undertaken under a controlled procedure so as to minimise the risk of a flammable gas or vapour being present while the work is being performed.

SAFETY WARNING

3) General work area

All maintenance staff and others working in the local area shall be instructed on the nature of work being carried out. Work in confined spaces shall be avoided. The area around the workspace shall be sectioned off. Ensure that the conditions within the area have been made safe by control of flammable material.

4) Checking for presence of refrigerant

The area shall be checked with an appropriate refrigerant detector prior to and during work, to ensure the technician is aware of potentially flammable atmospheres. Ensure that the leak detection equipment being used is suitable for use with flammable refrigerants, i.e. non-sparking, adequately sealed or intrinsically safe.

5) Presence of fire extinguisher

If any hot work is to be conducted on the refrigeration equipment or any associated parts, appropriate fire extinguishing equipment shall be available to hand. Have a dry powder or CO₂ fire extinguisher adjacent to the charging area.

6) No ignition sources

No person carrying out work in relation to a refrigeration system which involves exposing any pipe work that contains or has contained flammable refrigerant shall use any sources of ignition in such a manner that it may lead to the risk of fire or explosion. All possible ignition sources, including cigarette smoking, should be kept sufficiently far away from the site of installation, repairing, removing and disposal, during which flammable refrigerant can possibly be released to the surrounding space. Prior to work taking place, the area around the equipment is to be surveyed to make sure that there are no flammable hazards or ignition risks. "No Smoking" signs shall be displayed.

SAFETY WARNING

7) Ventilated area

Ensure that the area is in the open or that it is adequately ventilated before breaking into the system or conducting any hot work. A degree of ventilation shall continue during the period that the work is carried out. The ventilation should safely disperse any released refrigerant and preferably expel it externally into the atmosphere.

8) Checks to the refrigeration equipment

Where electrical components are being changed, they shall be fit for the purpose and to the correct specification. At all times the manufacturer's maintenance and service guidelines shall be followed. If in doubt consult the manufacturer's technical department for assistance.

The following checks shall be applied to installations using flammable refrigerants:

- The charge size is in accordance with the room size within which the refrigerant containing parts are installed;
- The ventilation machinery and outlets are operating adequately and are not obstructed;
- If an indirect refrigerating circuit is being used, the secondary circuit shall be checked for the presence of refrigerant;
- Marking to the equipment continues to be visible and legible. Markings and signs that are illegible shall be corrected;

SAFETY WARNING

– Refrigeration pipe or components are installed in a position where they are unlikely to be exposed to any substance which may corrode refrigerant containing components, unless the components are constructed of materials which are inherently resistant to being corroded or are suitably protected against being so corroded.

9) Checks to electrical devices

Repair and maintenance to electrical components shall include initial safety checks and component inspection procedures. If a fault exists that could compromise safety, then no electrical supply shall be connected to the circuit until it is satisfactorily dealt with. If the fault cannot be corrected immediately but it is necessary to continue operation, an adequate temporary solution shall be used. This shall be reported to the owner of the equipment so all parties are advised. Initial safety checks shall include:

- That capacitors are discharged: this shall be done in a safe manner to avoid possibility of sparking;
- That there no live electrical components and wiring are exposed while charging, recovering or purging the system;
- That there is continuity of earth bonding.

7. Repairs to sealed components (Annex DD.4)

1) During repairs to sealed components, all electrical supplies shall be disconnected from the equipment being worked upon prior to any removal of sealed covers, etc. If it is absolutely necessary to have an

SAFETY WARNING

electrical supply to equipment during servicing, then a permanently operating form of leak detection shall be located at the most critical point to warn of a potentially hazardous situation.

2) Particular attention shall be paid to the following to ensure that by working on electrical components, the casing is not altered in such a way that the level of protection is affected. This shall include damage to cables, excessive number of connections, terminals not made to original specification, damage to seals, incorrect fitting of glands, etc.

Ensure that apparatus is mounted securely.

Ensure that seals or sealing materials have not degraded such that they no longer serve the purpose of preventing the ingress of flammable atmospheres. Replacement parts shall be in accordance with the manufacturer's specifications.

NOTE: The use of silicon sealant may inhibit the effectiveness of some types of leak detection equipment. Intrinsically safe components do not have to be isolated prior to working on them.

8. Repair to intrinsically safe components (Annex DD.5)

Do not apply any permanent inductive or capacitance loads to the circuit without ensuring that this will not exceed the permissible voltage and current permitted for the equipment in use. Intrinsically safe components are the only types that can be worked on while live in the presence of a flammable atmosphere. The test apparatus shall be at the correct rating. Replace components only with parts specified by the manufacturer. Other parts may result in the ignition of refrigerant in the atmosphere from a leak.

SAFETY WARNING

9. Cabling (Annex DD.6)

Check that cabling will not be subject to wear, corrosion, excessive pressure, vibration, sharp edges or any other adverse environmental effects. The check shall also take into account the effects of aging or continual vibration from sources such as compressors or fans.

10. Detection of flammable refrigerants (Annex DD.7)

Under no circumstances shall potential sources of ignition be used in the searching for or detection of refrigerant leaks. A halide torch (or any other detector using a naked flame) shall not be used.

11. Leak detection methods (Annex DD.8)

The following leak detection methods are deemed acceptable for systems containing flammable refrigerants. Electronic leak detectors shall be used to detect flammable refrigerants, but the sensitivity may not be adequate, or may need re-calibration. (Detection equipment shall be calibrated in a refrigerant-free area.) Ensure that the detector is not a potential source of ignition and is suitable for the refrigerant used. Leak detection equipment shall be set at a percentage of the LFL of the refrigerant and shall be calibrated to the refrigerant employed and the appropriate percentage of gas (25 % maximum) is confirmed. Leak detection fluids are suitable for use with most refrigerants but the use of detergents containing chlorine shall be avoided as the chlorine may react with the refrigerant and corrode the copper pipe-work. If a leak is suspected, all naked flames shall be removed/ extinguished. If a leakage of refrigerant is found which requires brazing, all of the refrigerant shall be recovered from the system, or isolated (by means of shut off valves) in a part of the

SAFETY WARNING

system remote from the leak. Oxygen free nitrogen (OFN) shall then be purged through the system both before and during the brazing process.

12. Removal and evacuation (Annex DD.9)

When breaking into the refrigerant circuit to make repairs – or for any other purpose – conventional procedures shall be used. However, it is important that best practice is followed since flammability is a consideration. The following procedure shall be adhered to:

- Remove refrigerant;
- Purge the circuit with inert gas;
- Evacuate;
- Purge again with inert gas;
- Open the circuit by cutting or brazing.

The refrigerant charge shall be recovered into the correct recovery cylinders. The system shall be “flushed” with OFN to render the unit safe. This process may need to be repeated several times. Compressed air or oxygen shall not be used for this task. Flushing shall be achieved by breaking the vacuum in the system with OFN and continuing to fill until the working pressure is achieved, then venting to atmosphere, and finally pulling down to a vacuum. This process shall be repeated until no refrigerant is within the system. When the final OFN charge is used, the system shall be vented down to atmospheric pressure to enable work to take place. This operation is absolutely vital if brazing operations on the pipe-work are to take place. Ensure that the outlet for the vacuum pump is not close to any ignition sources and there is ventilation available.

SAFETY WARNING

13. Charging procedures (Annex DD.10)

In addition to conventional charging procedures, the following requirements shall be followed.

- Ensure that contamination of different refrigerants does not occur when using charging equipment. Hoses or lines shall be as short as possible to minimise the amount of refrigerant contained in them.
- Cylinders shall be kept upright.
- Ensure that the refrigeration system is earthed prior to charging the system with refrigerant.
- Label the system when charging is complete (if not already).
- Extreme care shall be taken not to overfill the refrigeration system. Prior to recharging the system it shall be pressure tested with OFN. The system shall be leak tested on completion of charging but prior to commissioning. A follow up leak test shall be carried out prior to leaving the site.

14. Decommissioning (Annex DD.11)

Before carrying out this procedure, it is essential that the technician is completely familiar with the equipment and all its detail. It is recommended good practice that all refrigerants are recovered safely. Prior to the task being carried out, an oil and refrigerant sample shall be taken in case analysis is required prior to re-use of reclaimed refrigerant. It is essential that electrical power is available before the task is commenced.

- a) Become familiar with the equipment and its operation.
- b) Isolate system electrically.
- c) Before attempting the procedure ensure that:
 - Mechanical handling equipment is available, if required, for handling refrigerant cylinders;
 - All personal protective equipment is available and being used correctly;
 - The recovery process is supervised at all times by a competent person;

SAFETY WARNING

- Recovery equipment and cylinders conform to the appropriate standards.
- d) Pump down refrigerant system, if possible.
- e) If a vacuum is not possible, make a manifold so that refrigerant can be removed from various parts of the system.
- f) Make sure that cylinder is situated on the scales before recovery takes place.
- g) Start the recovery machine and operate in accordance with manufacturer's instructions.
- h) Do not overfill cylinders. (No more than 80 % volume liquid charge).
- i) Do not exceed the maximum working pressure of the cylinder, even temporarily.
- j) When the cylinders have been filled correctly and the process completed, make sure that the cylinders and the equipment are removed from site promptly and all isolation valves on the equipment are closed off.
- k) Recovered refrigerant shall not be charged into another refrigeration system unless it has been cleaned and checked.

15. Labelling (Annex DD.12)

Equipment shall be labelled stating that it has been de-commissioned and emptied of refrigerant. The label shall be dated and signed. Ensure that there are labels on the equipment stating the equipment contains flammable refrigerant.

16. Recovery (Annex DD.13)

When removing refrigerant from a system, either for servicing or decommissioning, it is recommended good practice that all refrigerants are removed safely. When transferring refrigerant into cylinders, ensure that only appropriate refrigerant recovery cylinders are employed. Ensure that the correct number of cylinders for holding

SAFETY WARNING

the total system charge is available. All cylinders to be used are designated for the recovered refrigerant and labelled for that refrigerant (i.e. special cylinders for the recovery of refrigerant). Cylinders shall be complete with pressure relief valve and associated shut-off valves in good working order. Empty recovery cylinders are evacuated and, if possible, cooled before recovery occurs.

The recovery equipment shall be in good working order with a set of instructions concerning the equipment that is at hand and shall be suitable for the recovery of flammable refrigerants. In addition, a set of calibrated weighing scales shall be available and in good working order. Hoses shall be complete with leak-free disconnect couplings and in good condition. Before using the recovery machine, check that it is in satisfactory working order, has been properly maintained and that any associated electrical components are sealed to prevent ignition in the event of a refrigerant release. Consult manufacturer if in doubt.

The recovered refrigerant shall be returned to the refrigerant supplier in the correct recovery cylinder, and the relevant Waste Transfer Note arranged. Do not mix refrigerants in recovery units and especially not in cylinders. If compressors or compressor oils are to be removed, ensure that they have been evacuated to an acceptable level to make certain that flammable refrigerant does not remain within the lubricant. The evacuation process shall be carried out prior to returning the compressor to the suppliers. Only electric heating to the compressor body shall be employed to accelerate this process. When oil is drained from a system, it shall be carried out safely.



SAFETY WARNING

- This appliance is not intended for use by persons (including children) with reduced physical, sensory or mental capabilities, or lack of experience and knowledge, unless they have been given supervision or instruction concerning use of the appliance by a person responsible for their safety.
- Children should be supervised to ensure that they do not play with the appliance.
- Cleaning and user maintenance shall not be made by children without supervision.
- Before operation, please confirm whether power specification complies with that on nameplate.
- Before cleaning or maintaining the air conditioner, please turn off air conditioner and pull out the power plug.
- Make sure the power cord hasn't been pressed by hard objects.
- Do not pull or drag the power cord to pull out the power plug or move the air conditioner.
- Do not insert or pull out the power plug with wet hands.
- Please make sure connected to properly grounded power outlet.
- If the power cord is damaged, it must be replaced by the manufacturer or its service agent in order to avoid hazard.
- If abnormal condition occurs (e.g. burned smell), please disconnect power at once and then contact local dealer.
- When nobody is taking care of the unit, please turn it off and remove the power plug or disconnect power.
- Do not splash or pour water on air conditioner. Otherwise, it may cause short circuit or damage to air conditioner.
- If drainage hose is used, ambient temperature can't be lower than 0°C. Otherwise, it will cause water leakage to air conditioner.
- Prohibit operating heating equipment around the air conditioner.
- Far away from fire source, inflammable and explosive objects.
- Do not put or hang dripping objects above the air conditioner.
- Do not modify or alter the characteristics of the appliance in any way.
- Prohibit inserting any objects into the air conditioner.
- If the appliance requires repair, contact the TECO National Service Centre. Repairs carried out by unauthorised personnel may be dangerous.

DESCRIPTION

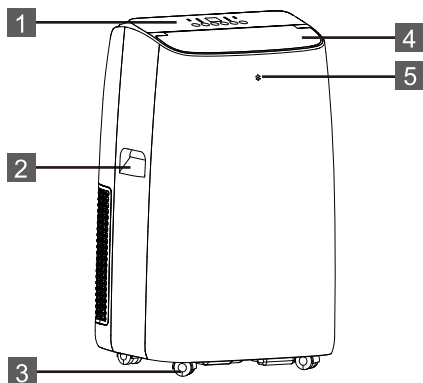

1. Control panel
2. Handle (both sides)
3. Castors
4. Deflector
5. Remote receiver
6. Intake grille

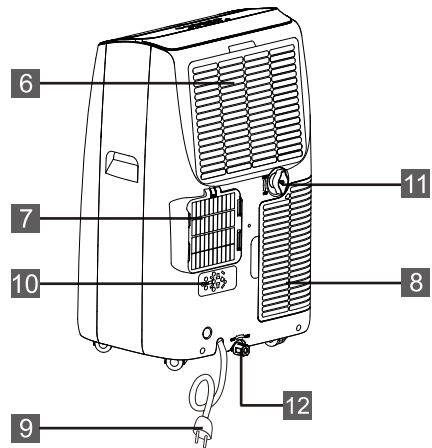

7. Air outlet grille
8. Intake grille
9. Power cable
10. Middle drainage
11. Condenser drain

ACCESSORIES

PARTS	PARTS NAME	QUANTITY
	Exhaust hose Hose outlet Hose inlet	1 set
	Window slider kit	1 set
	Remote Control Battery	1 set
	Drainage hose	1 set

Note: All the illustrations in this manual are for explanatory purposes only.
Your appliance may be slightly different.

INSTALLATION INSTRUCTIONS

EXHAUSTING HOT AIR

In the Cool Mode the appliance must be placed close to a window or opening so that the warm exhaust air can be ducted outside.

First position unit on a flat floor and make sure there's a minimum of 12" (30cm) clearance around the unit, and is within the vicinity of a single circuit outlet power source.

1. Extend either side of the hose (Fig.1) and screw the hose inlet (Fig.2).
2. Extend the other side of the hose and screw it to the hose outlet (Fig.3).
3. Install the hose inlet into the unit (Fig.4).
4. Affix the hose outlet into the window slider kit and seal (Fig.5 & 6).

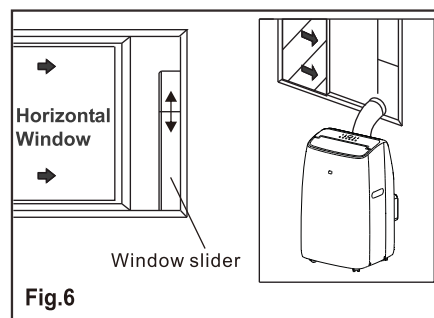
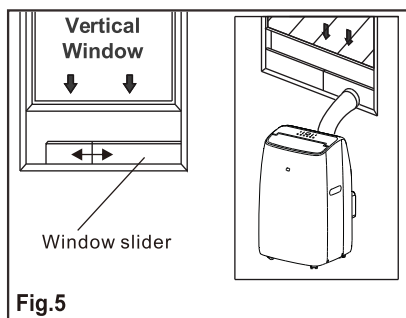
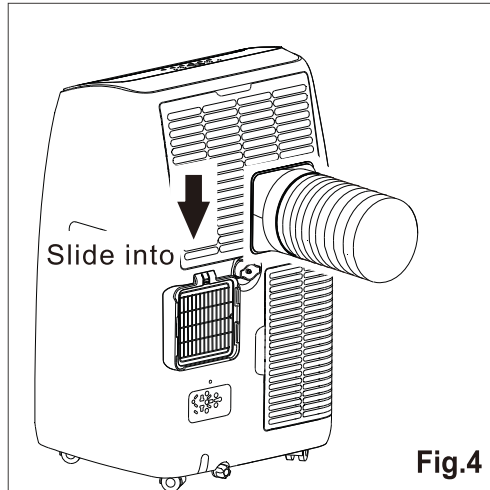
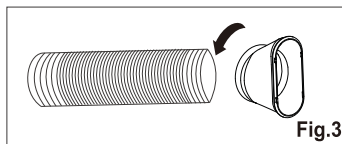
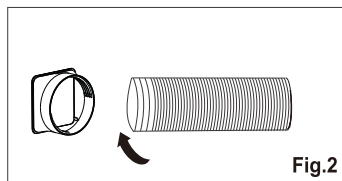
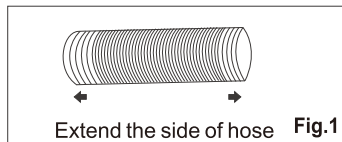

INSTALLATION INSTRUCTIONS

Your window slider kit has been designed to fit most standard vertical and horizontal window applications, however, it may be necessary for you to modify some aspects of the installation procedures for certain types of windows. The window slider kit can be fastened with screws.

NOTE: If the window opening is less than the minimum length of the window slider kit, cut the end without the hole in it short enough to fit in the window opening. Never cut out the hole in window slider kit.

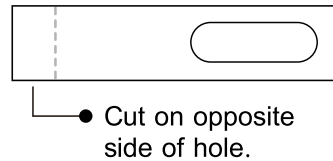

WINDOW SLIDER KIT INSTALLATION

1: Parts:

- A) Panel
- B) Panel with one hole.
- D) Screw to lock window kit in place.

2: Assembly:

Slide Panel B into Panel A and size to window width. Windows sizes vary. When sizing the window width, be sure that the window kit assembly is free from gaps from gaps and/or air pockets when taking measurements

3: Lock the screw into the holes that correspond. With the width that your window requires to ensure that there are no gaps or air pockets in the window kit assembly after installation.

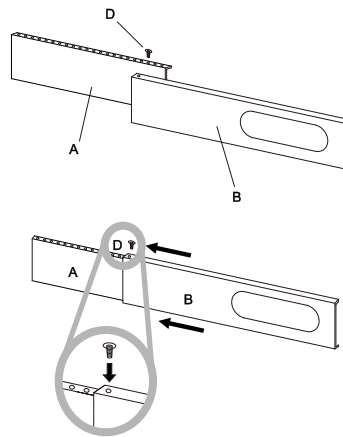

NOTE:
TECO PUSH/PULL WINDOW KIT (MODEL:TPPWKITT) is also available for purchase.
Contact your local retailer, sales agency or check TECO Australia website for more information.

INSTALLATION INSTRUCTIONS

LOCATION

- The unit should be placed on a firm foundation to minimize noise and vibration. For safe and secure positioning, place the unit on a smooth, level floor strong enough to support the unit.
- The unit has casters to aid placement, but it should only be rolled on smooth, flat surfaces. Use caution when rolling on carpeted surfaces. Use caution and Protect floors when rolling over wood floors. Do not attempt to roll the unit over objects.
- The unit must be placed within reach of a properly rated grounded socket.
- Never place any obstacles around the air inlet or outlet of the unit.
- Allow at least 45cm of space away from the wall for efficient air conditioning.
- The hose can be extended, but it is the best to keep the length to minimum required. Also make sure that the hose does not have any sharp bends or sags.

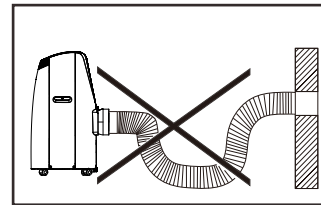
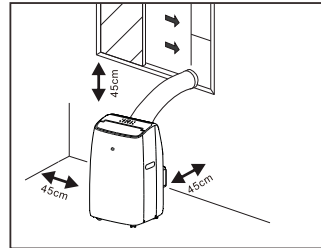

TIPS FOR CORRECT USE

To get the best from your appliance, follow these recommendations:

- Close the windows and doors in the room to be air conditioned (Fig. 7). When installing the appliance semi-permanently, you should leave a door slightly open (as little as 1 cm) to guarantee correct ventilation;
- Protect the room from direct exposure to the sun by partially closing curtains and/or blinds to make the appliance much more economical to run (Fig. 8);
- Never rest objects of any kind on the appliance;
- Do not obstruct the air intake and outlet (Fig. 9). Leave the grilles free;
- Make sure there are no heat sources in the room;
- Never use the appliance in very damp rooms (laundries for example).
- Never use the appliance outdoors.
- Make sure the appliance is standing on a level surface. if necessary, place the castor locks under the front wheels.

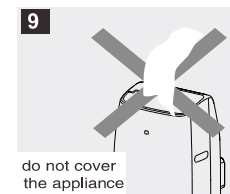
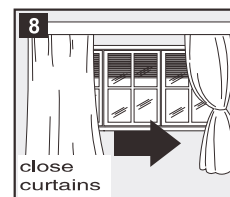
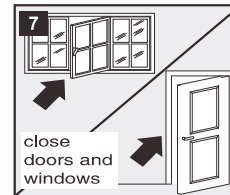

DESCRIPTION OF THE DISPLAY SCREEN

CONTROL PANEL

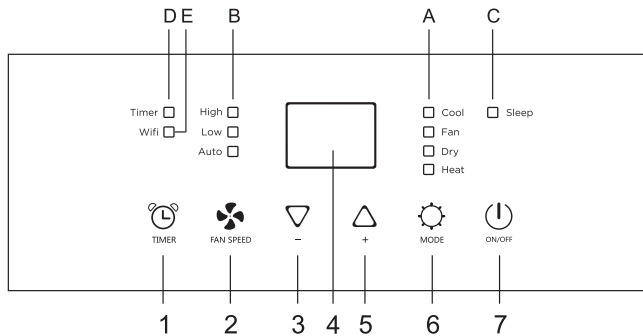

- A. Mode symbol*
 - B. Fan speed symbol
 - C. Sleep symbol
 - D. Timer symbol
 - E. WiFi symbol
1. Timer button
 2. Fan speed button
 3. Decrease button
 4. Display screen
 5. Increase button
 6. MODE button
 7. ON/OFF button

* * Only the heat pump model have the Heat function.

Note: The WIFI symbol lighted on when the unit is connected to the smart device. Please refer to Wireless Operation Manual for more information.

OPERATING FROM THE CONTROL PANEL

The control panel is on the top of the appliance, enables you to manage part functions without remote controller, but to fully exploit its potential, you must use the remote controller.

TURNING THE APPLIANCE ON

Plug into the mains socket then the appliance is standby.

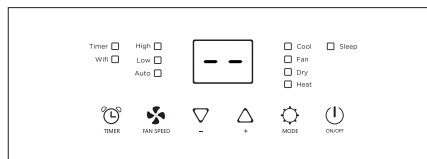

Press the ⏻ button to make the appliance turn on. The last function active when it was turned off will appear.



✓ Never turn the appliance off by unplugging from the mains. Always press the ⏻ button, then wait for a few minutes before unplugging. This allows the appliance to perform a cycle of checks to verify operation.

OPERATION INTRODUCTION FOR CONTROL PANEL

1) COOL mode

Ideal for hot muggy weather when you need to cool and dehumidify the room.

To set this mode correctly:

- Press the  button a number of times until the Cool symbol appears.
- Select the target temperature 18°C-32°C (64°F-90°F) by pressing the ▲ or ▼ button until the corresponding value is displayed.
- Select the required fan speed by pressing the  button.

three speeds are available: High / Low / Auto.

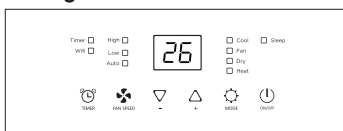



The most suitable temperature for the room during the summer varies from 24°C to 27°C (75°F to 81°F). You are recommended, however, not to set a temperature much below the outdoor temperature. The fan speed difference is more noticeable when the appliance is under FAN mode but may not be noticeable under COOL mode.

2) HEAT mode

NOTE: *Heat Pump Model Only.

To set this mode correctly:

- Press the  button a number of times until the Heat symbol appears.
- Select the target temperature 13°C-27°C (55°F-81°F) by pressing the ▲ or ▼ button until the corresponding value is displayed.
- Select the required fan speed by pressing the  button.

three speeds are available: High / Low / Auto.

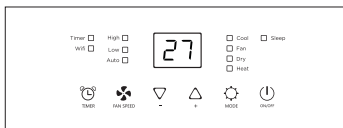

- Water is removed from the air and collected in the tank.
- When the tank is full, the appliance shuts down and "Ft" (full tank) appears on the display. The tank cap must be extracted and emptied. Run off all water left into a basin. When all the water has been drained, put the cap back in place.
- When the tank has been emptied, the appliance starts up again.

N.B.: - When operating in very cold rooms, the appliance defreezes automatically, momentarily interrupting normal operation.



During this operation, it is normal for the noise made by the appliance to change.

- In this mode, you may have to wait for a few minutes before the appliance starts giving out hot air.
- In this mode, the fan may operate for short periods, even though the set temperature has already been reached.

OPERATION INTRODUCTION FOR CONTROL PANEL

3) FAN mode

When using the appliance in this mode, the air hose does not need to be attached.

- Press the  button a number of times until the Fan symbol appears.
- Select the required fan speed by pressing the  button.

Two speeds are available: High / Low.

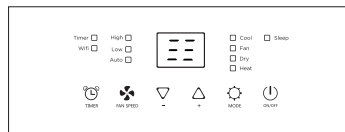

The screen display " 



4) DRY mode

Ideal to reduce room humidity (spring and autumn, damp rooms rainy periods, etc). In dry mode, the appliance should be prepared in the same way as for cool mode, with the air exhaust hose attached to enable the moisture to be discharged outside.

To set this mode correctly:



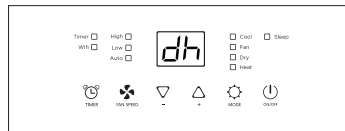

- Press the  button a number of times until the Dry symbol appears. The screen display "".
- In this mode, fan speed is selected automatically by the appliance and can not be set manually.



5) SETTING THE TIMER





-This timer can be used to delay the appliance startup or shutdown, this avoids wasting electricity by optimising operating periods.

Programming Start Up

- Turn on the appliance, choose the mode you want, for example cool, 24°C, high fan speed. Turn off the appliance.
- Press the Timer button, the  symbol and number of hours flash.
- Press the  button to set the number of hours delay before the appliance comes on. The timer can set in intervals of 1 hours up to 24 hours.
- A few second after set, the setting is memorized, the timer indicator is light and the display shows that the appliance is in standby.
- Press again the Timer button or the  button, the timer will be canceled, and the  symbol will disappear from screen.

OPERATION INTRODUCTION FOR CONTROL PANEL

Programming Shut Down

- When the appliance is running, press the  button, the Timer indicator and the hours flash.
- Press the  button to set the number of hours delay before the appliance comes on. The timer can set in intervals of 1 hours up to 24 hours.
- A few second after set, the setting is memorized, the timer indicator is light and the display shows the current mode. At the end of the set time the unit automatically turns to standby mode.
- Press again the Timer button or the  button, the timer will be canceled, and the  symbol will disappear from screen.

6) SMART mode

The appliance chooses automatically whether to operate in cool, fan or heat mode. To set this mode correctly:

- Press the  button a number of times until the screen show like below:

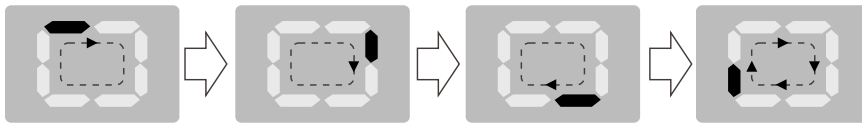



- Select the required fan speed by pressing the  button. three speeds are available: High / Low / Auto.

The unit operates in Heat mode when the room temperature is below 20 (68°F) , and Fan mode when the room temperature is from 20°C (68°F) to 23°C (73°F) , and Cool mode when the room temperature is above 23°C (73°F) .

7) WIFI function

- In the stand-by, press “  ” button six times in four seconds to reset the Wifi signal, so that the appliance will “beep” twice. Then please refer to Wireless Operation Manual to connect the appliance. If it is successful, the Wifi indicator light on operational panel will be lightened.

8) Switch the unit of temperature

- When the appliance is running, hold on  and  button together 3 seconds by the same time, then you can change the unit of temperature.



USING THE REMOTE CONTROL

REMOTE CONTROLLER

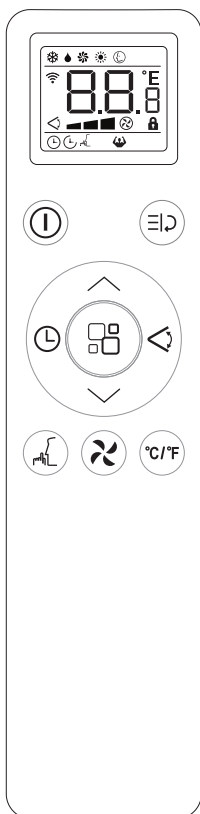

	On/Off button		Fan speed button
	Increase button		Mode button
	Decrease button		Swing button
	Timer button		Sleep button
	Unit switch button		Function button

	COOL symbol		SLEEP symbol
	DRY symbol		TimerON symbol
	FAN symbol		TimerOFF symbol
	HEAT symbol		Fan speed symbol
	SMART symbol		Turbo symbol
	SWING symbol		Child lock symbol

- ✓ Point the remote control at the receiver on the appliance.
- ✓ The remote control must be no more than 7 meters away from the appliance (without obstacles between the remote control and the receiver).
- ✓ The remote control must be handled with extreme care. Do not drop it or expose it to direct sunlight or sources of heat. If the remote control do not work, please try to take out the battery, and put it back.

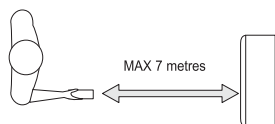

USING THE REMOTE CONTROL

INSERTING OR REPLACING THE BATTERIES

- Remove the cover on the rear of the remote control;
- Insert two "AAA" 1.5V batteries in the correct position (see instructions inside the battery compartment);
- Replace the cover.







NOTE:

- If the remote control unit is replaced or disposed of, the batteries must be removed and discarded in accordance with current legislation as they are harmful to the environment.
- Do not mix old and new batteries. Do not mix alkaline, standard (carbon-zinc) or rechargeable (nickel-cadmium) batteries.
- Do not dispose of batteries in fire. Batteries may explode or leak.
- If the remote control is not be used for a certain length of time, remove the batteries.





COOL mode

Ideal for hot muggy weather when you need to cooling and dehumidify the room

To set this mode correctly:

- Press the  button a number of times until the ❄️ symbol appears.
- Select the target temperature 18°C-32°C (64°F-90°F) by pressing the  or  button until the corresponding value is displayed.
- Select the required fan speed by pressing the  button. three speeds are available: High / Low / Auto.



Low		High		Auto
				

The most suitable temperature for the room during the summer varies from 24°C to 27°C (75°F to 81°F) . You are recommended, however, not to set a temperature much below than the outdoor temperature.





USING THE REMOTE CONTROL

HEAT mode *

* * means only the heat pump model have this function.

If the appliance is cooling only, when choose this function, will turn to FAN mode.

To set this mode correctly:

- Press the  button a number of times until the  symbol appears.
- Select the target temperature 13°C-27°C(55°F-81°F) by pressing the  or  button until the corresponding value is displayed.
- Select the required fan speed by pressing the  button.
Three speeds are available: High / Low / Auto.



- Water is removed from the air and collected in the tank.
- When the tank is full, the appliance shuts down and "F.L" (full tank) appears on the display. The tank cap must be extracted and emptied. Run off all water left into a basin. When all the water has been drained, put the cap back in place.
- When the tank has been emptied, the appliance starts up again.



N.B.: - When operating in very cold rooms, the appliance defreezes automatically, momentarily interrupting normal operation. During this operation, it is normal for the noise made by the appliance to change.

- In this mode, you may have to wait for a few minutes before the appliance starts giving out hot air.

- In this mode, the fan may operate for short periods, even though the set temperature has already been reached.

FAN mode

When using the appliance in this mode, the air hose does not need to be attached.

- Press the  button a number of times until the "" symbol appears.
- Select the required fan speed by pressing the  button.
Two speeds are available: High / Low.





DRY mode

Ideal to reduce room humidity (spring and autumn, damp rooms rainy periods, etc).

In dry mode, the appliance should be prepared in the same way as for cool mode, with the air exhaust hose attached to enable the moisture to be discharged outside.

To set this mode correctly:

- Press the  button a number of times until the  symbol appears.
- In this mode, fan speed is selected automatically by the appliance and can not be set manually.

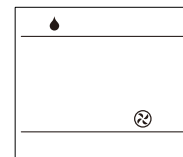



USING THE REMOTE CONTROL

SMART mode

The appliance chooses automatically whether to operate in cool, fan or heat mode.

To set this mode correctly:

- Press the  button a number of times until the  symbol appears.
- Select the required fan speed by pressing the  button. Three speeds are available: High / Low / Auto.

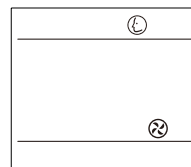





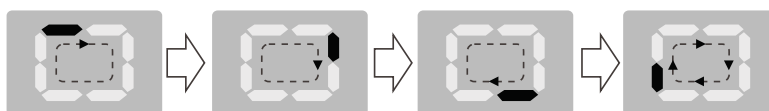





The unit operates in Heat mode when the room temperature is below 20°C (68°F) , and Fan mode when the room temperature is from 20°C (68°F) to 23°C(73°F) , and Cool mode when the room temperature is above 23°C (73°F) .

Display on the control panel:



It is SMART mode when the display will be running circulating.

Turbo function

- Press the  button , the  symbol flash on screen, press the  button Again to confirm, the  will stop flash and show on screen, that the function is working.
- This function set the appliance directly to COOL mode with setting temperature 18°C(64°F) and High fan speed in order to reach low temperature in the shortest time.
- This function can not be set in Heat mode.
- To cancel this function, press the  , the  flash on screen, and then press the  button again to confirm , the  will stop flash and disappear from screen.
- Press other button like “  ” or “  ” or “  ” also can cancel this function.



SWING function

This function is useful for select the up/down swing of air delivery.

To set this function correctly:

- Select the operating mode (cool, dry, fan) as described above.
- Press the  button, the deflector will start or stop swing.

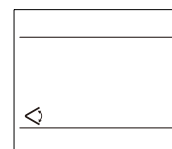

USING THE REMOTE CONTROL

SLEEP function

This function is useful for the night as it gradually reduces operation of the appliance. To set this function correctly:

— Select the desired mode. (Not applicable to FAN mode).

— Press the “” button.

The appliance operates in the previously selected mode.

When you choose the sleep function, the screen will reduce the brightness, and the fan speed is low.

The SLEEP function maintains the room at optimum temperature without excessive fluctuations in either temperature or humidity with silent operation. Fan speed is always at Low, while room temperature and humidity vary gradually to ensure the most comfortable.











When in COOL mode, the selected temperature will increase by 1°C(1°F) per hour in a 2 hour period. This new temperature will be maintained for the next 6 hours. Then the appliance turn it off.

When in HEAT mode, the selected temperature will decrease by 1°C(1°F) per hour in a 3 hour period. This new temperature will be maintained for the next 5 hours. Then the appliance turn it off.

When in Dry mode, the unit will automatically set the temperature 2°C lower than the ambient temperature at the time the sleep function is activated and maintained for the next 8 hours. Then the appliance turns it off.

The SLEEP function can be canceled at any time during operation by pressing the "Sleep", "Mode" or "fan speed" button.





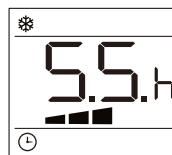



Programming start up

- Turn on the appliance, choose the mode you want, for example cool, 24°C, high fan speed. Turn off the appliance.
- Press the  button twice, the screen will display 0.5-24 hours, and the  symbol and “” symbol is flash.
- Press the  or  button several times until the corresponding time is displayed. Press the  button again, the timer will be active, then the  symbol displayed on screen.
- Press again the  button or the  button, the timer will be canceled, and the  symbol disappear .



USING THE REMOTE CONTROL

Programming shut down

- When the appliance is running, press the  button, the screen will display 0.5-24 hours, the  symbol and “ h ” symbol is flash.
- Press the  or  button several times until the corresponding time is displayed. Press the  button again, the timer will be active, then the  symbol displayed on screen.
- Press again the  button or the  button, the timer will be canceled, and the  symbol disappear .



Switch the unit of temperature

When the appliance is running, press the °C/°F button, then you can change the unit of temperature.

For example:



Before change, in cool mode, the screen display like fig left.

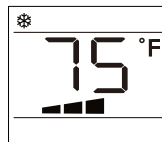

After change, in cool mode, the screen display like fig right.



CHILD-LOCK function

This function is used to prevent children from pressing remote controller carelessly or accidentally.

- Hold the  and  button together about 3 seconds to active the child-lock function, and the “  ” symbol is appear on screen.
- When this function is active, it will not respond to any actions.

- Hold the  and  button together about 3 seconds again, the child-lock will be canceled, and the “  ” symbol is disappear.

REMOVING COLLECTED WATER

WATER DRAINAGE METHOD

When there is excess water condensation inside the unit, the appliance stops running and shows “F_L”(FULL TANK as mentioned in SELF-DIAGNOSES). This indicates that the water condensation needs to be drained using the following procedures:

Manual Draining (Fig.12)

Water may need to be drained in high humidity areas

1. Unplug the unit from power source.
2. Place a drain pan (Not supplied) under the lower drain plug.
3. Remove the lower drain plug.
4. Water will drain out and collect in the drain pan.
5. After the water is drained, replace the lower drain plug firmly.
6. Turn on the unit.

Continuous Draining (Fig.13)

While using the unit in HEAT mode, continuous drainage is recommended.

1. Unplug the unit from the power source.
2. Remove the drain plug. While doing this operation some residual water may spill so please have a pan to collect the water.
3. Connect the drain hose (1/2" or 12.7mm). See diagram.
4. The water can be continuously drained through the hose into a floor drain or bucket.
5. Turn on the unit.

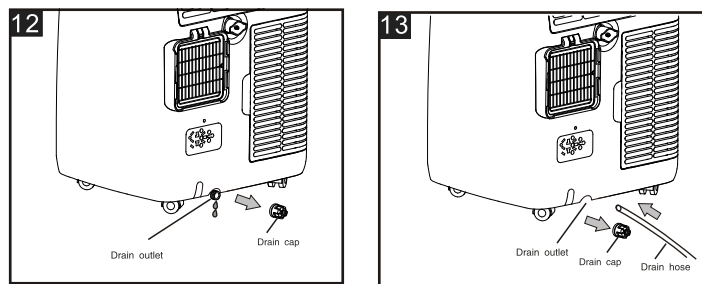

Note: Please be sure that the height of and section of the drain hose should not be higher than the drain outlet, or the water tank may not be drained properly. (Fig.14 and Fig.15)

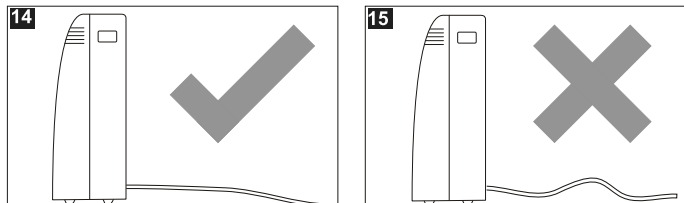

REMOVING COLLECTED WATER

Middle drainage

When unit running in Dry mode, you can choose the way below to drainage.

1. Unplug the unit from the power source.
2. Remove the drain plug (fig 14). While doing this operation some residual water may spill so please have a pan to collect the water.
3. Connect the drain hose (1/2" or 12.7mm, maybe not supplied). (fig 15)
4. The water can be continuously drained through the hose into a floor drain or bucket.
5. Turn on the unit.

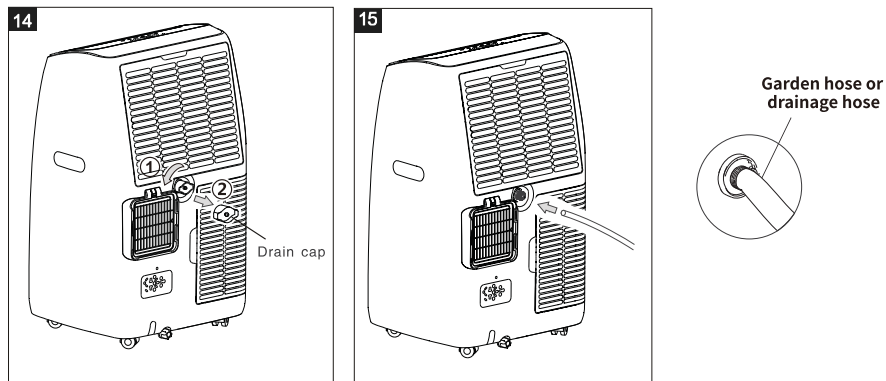

Note: Please be sure that the height of and section of the drain hose should not be higher than the drain outlet, or the water tank may not be drained properly. (Fig.16 and Fig.17)

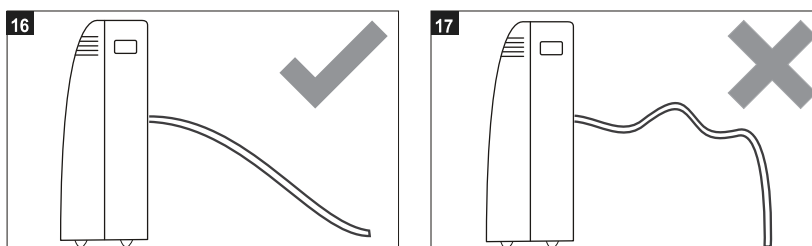

CLEAN AND MAINTENANCE

Before cleaning or maintenance, turn the appliance off by pressing the  button on the control panel or remote control, wait for a few minutes then unplug from the mains socket.

CLEANING THE CABINET

You should clean the appliance with a slightly damp cloth then dry with a dry cloth.

- Never wash the appliance with water. It could be dangerous.
- Never use petrol, alcohol or solvents to clean the appliance.
- Never spray insecticide liquids or similar.

Silver ion filter

The dust filter is treated with silver ions which not just retain dust particles, but also have an efficient antibacterial action. It also greatly reduces concentrations of irritants such as pollen and spores.

CLEANING THE AIR FILTERS

To keep your appliance working efficiently, you should clean the filter every week of operation.

The evaporator filter can take out like below Fig. 18

It is recommended to do this at least once a month or more frequently if the appliance is used frequently or continuously.

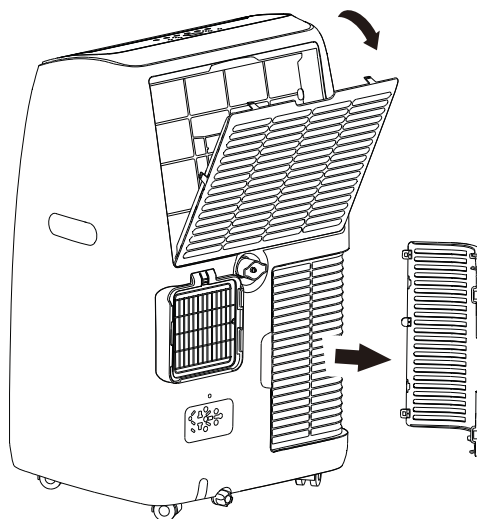

Fig.18

CLEAN AND MAINTENANCE

Use a vacuum cleaner to remove dust accumulations from the filter. If it is very dirty, immerse in warm water and rinse a number of times. The water should never be hotter than 40°C (104°F). After washing, leave the filter to dry then attach the intake grille to the appliance.

START OF SEASON CHECKS

Make sure the power cable and plug are undamaged and the earth system is efficient. Follow the installation instructions precisely.

END OF SEASON OPERATIONS

To empty the internal circuit completely of water, remove the cap (Fig. 19). Run off all water left into a basin. When all the water has been drained, put the cap back in place. Clean the filter and dry thoroughly before putting back.

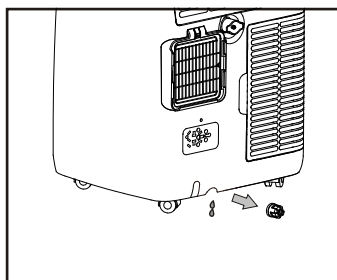

Fig.19



TROUBLESHOOTING

PROBLEM	CAUSE	SOLUTION
The appliance does not come on	<ul style="list-style-type: none"> • There is no current • It is not plugged into the mains • The internal safety device has tripped 	<ul style="list-style-type: none"> • Wait • Plug into the mains • Wait 30 minutes, if the problem persists, contact your service center
The appliance works for a short time only	<ul style="list-style-type: none"> • Here are bends in the air exhaust hose • Something is preventing the air from being discharged 	<ul style="list-style-type: none"> • Position the air exhaust hose correctly, keeping it as short and free of curves as possible to avoid bottlenecks • Check and remove any obstacles obstructing air discharge
The appliance works, but does not cool the room	<ul style="list-style-type: none"> • Windows, doors and/or curtains open 	<ul style="list-style-type: none"> • Close doors, windows and curtains, bearing in mind the "tips for correct use" given above
	<ul style="list-style-type: none"> • There are heat sources in the room (oven, hairdryer, etc) 	<ul style="list-style-type: none"> • Eliminate the heat sources
	<ul style="list-style-type: none"> • The air exhaust hose is detached from the appliance 	<ul style="list-style-type: none"> • Fit the air exhaust hose in the housing at the back of the appliance
	<ul style="list-style-type: none"> • The technical specification of the appliance is not adequate for the room in which it is located 	
During operation, there is an unpleasant smell in the room	<ul style="list-style-type: none"> • Air filter clogged 	<ul style="list-style-type: none"> • Clean the filter as described above
The appliance does not operate for about three minutes after restarting it	<ul style="list-style-type: none"> • The internal compressor safety device prevents the appliance from being restarted until three minutes have elapsed since it was last turned off 	<ul style="list-style-type: none"> • Wait. This delay is part of normal operation
The following message appears on the display: PF/ F E	<ul style="list-style-type: none"> • The appliance has a self diagnosis system to identify a number of malfunctions 	<ul style="list-style-type: none"> • See the SELF-DIAGNOSIS Chapter

TROUBLESHOOTING

SELF-DIAGNOSIS

The appliance has a self diagnosis system to identify a number of malfunctions. Error messages are displayed on the appliance display.

IF IS DISPLAYED	WHAT SHOULD I DO?
 PROBE FAILURE (sensor damaged)	If this is displayed, contact your local authorize service centre.
 FULL TANK (safety tank full)	Empty the internal safety tank, following the instructions in the "End of season operations" paragraph.

WARNING

- If there are following phenomenon, please turn off the air conditioner and disconnect the power immediately, and then contact dealer immediately.
 - Power cord is overheating or damaged.
 - Abnormal sound during operation.
 - Off-flavor.
 - Water leakage
- Do not repair or refit the air conditioner by yourself.
- If operate the air conditioner under abnormal condition, it may cause malfunction, electric shock or fire hazard.

Repairs, Service & Warranty

It is hazardous for anyone installing, removing, altering, repairing, servicing, testing or certifying the gas system of a gas device (i.e. charging, discharging or breaking into the refrigeration system that uses hydrocarbon refrigerants).

Only an Authorised Service Person can carry out servicing or repairs to this appliance. In Queensland the authorised person must hold a Gas Work Authorisation for hydrocarbon refrigerants, before carrying out servicing or repairs which involve the removal of covers.

Individuals will need to hold appropriate refrigeration/air conditioning competencies and also training in hydrocarbon refrigerants. This type of authorisation is provided to individuals only.

IF SERVICE IS REQUIRED:

If you have a problem, and the problem persists after you have made the checks mentioned in this manual, contact:

TECO Australia's Service on 1300 660 037
(8:30am - 4pm Mon~Fri AEST)

For warranty details please visit www.teco.com.au

Service Email: had.service@teco.com.au

Spare Parts: had.parts@teco.com.au



Dispose of old appliances in accordance with local regulations. Remove the doors, cut off the main cable, break or remove spring or bolt catches if fixed to prevent children getting trapped or involve themselves in other dangers.

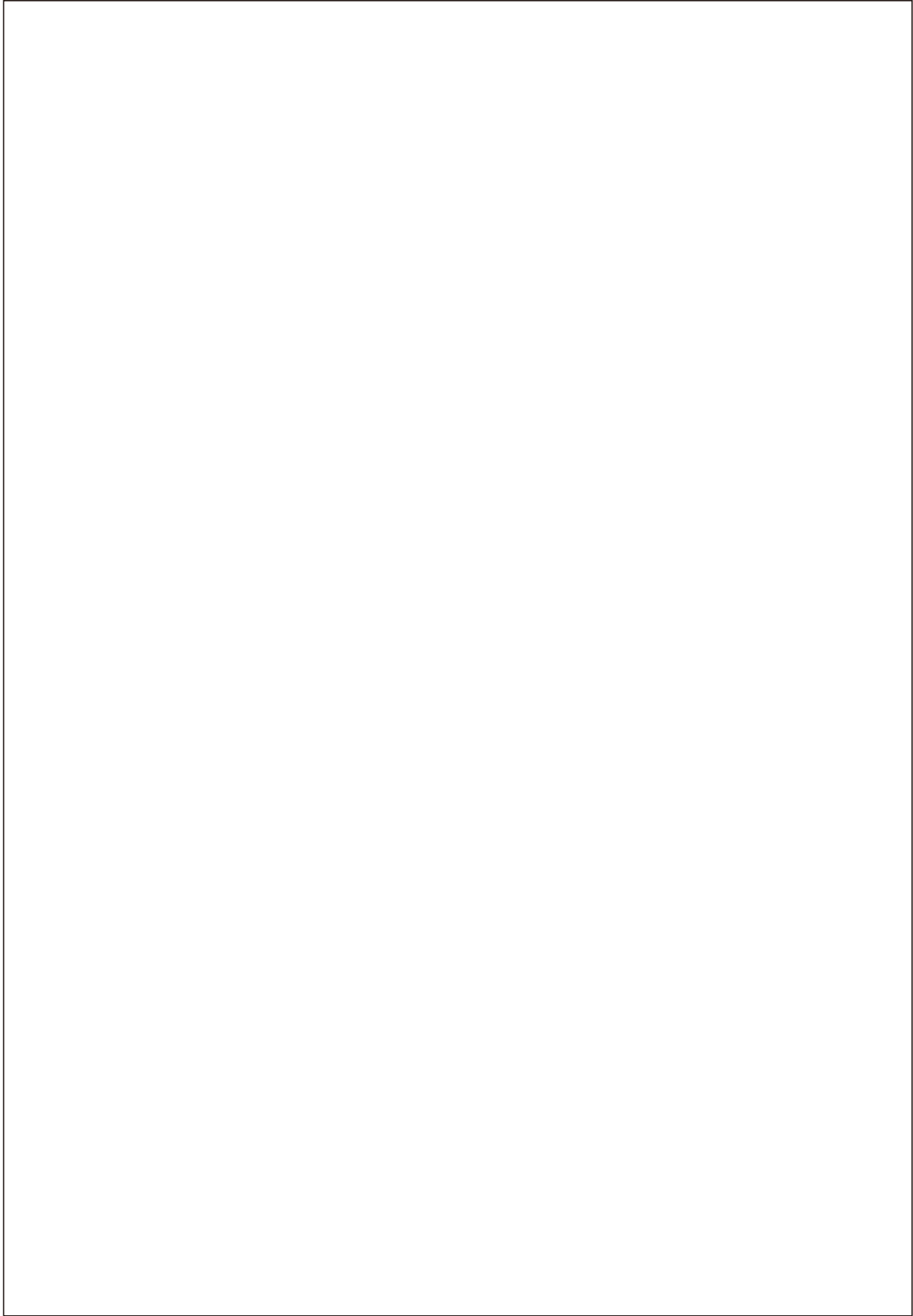

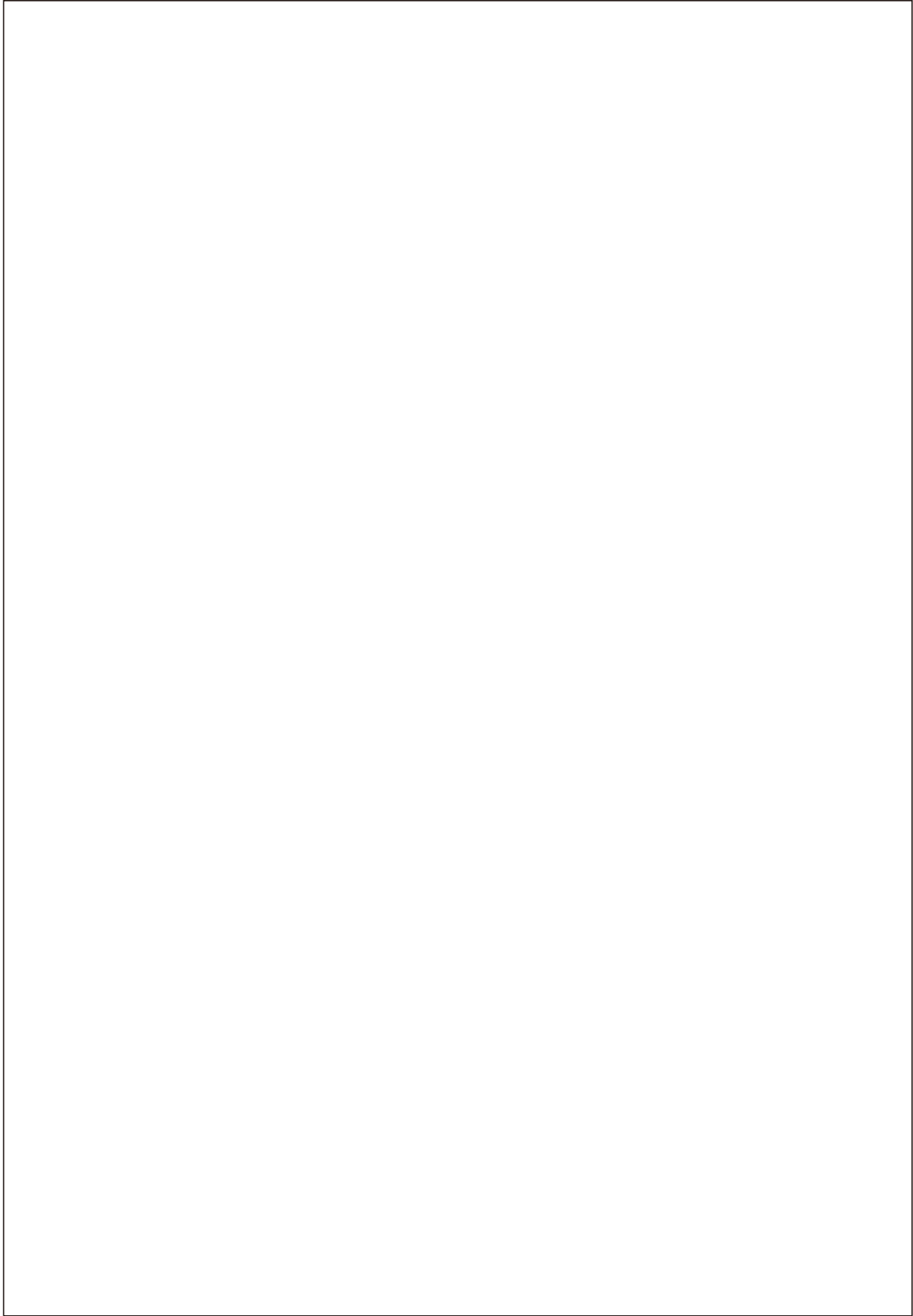

Did you know?

TECO Australia's product range also includes:

- ◆ Top Load Clothes Washers
- ◆ Front Load Clothes Washers
- ◆ Auto Sensing Vented Clothes Dryers
- ◆ Refrigerators
- ◆ Chest and Vertical Freezers
- ◆ Bar Fridges
- ◆ Televisions
- ◆ Air Curtains
- ◆ Air Conditioners

Visit www.teco.com.au for our full range.

Portable Air Conditioner

USER'S MANUAL - JUNE 2024

Original instructions

TPO35CFWET

TPO35HFWET

HEAD OFFICE AUSTRALIA

TECO Australia Pty Limited

335-337 Wood park Road,
Smithfield NSW 2164

P: +6129765 8118

F: +6129765 8185

E: hadsales.central@teco.com.au

W: www.teco.com.au

VIC/SA/TAS

TECO Australia Pty Limited

16 Longstaff Road,
Bayswater VIC 3153

P: +61 3 9720 4411

E: hadsales.central@teco.com.au

WA

TECO Australia Pty Limited

18 Hazelhurst Street,
Kewdale WA 6105

P: +61 8 9479 4879

E: hadsales.wa@teco.com.au

QLD

TECO Australia Pty Limited

50 Murdoch Circuit,
Acacia Ridge QLD 4110

P: +61 7 3373 9600

E: hadsales.central@teco.com.au